

STAND CONSTRUCTION DETAILS

basic stand OCTA_Display

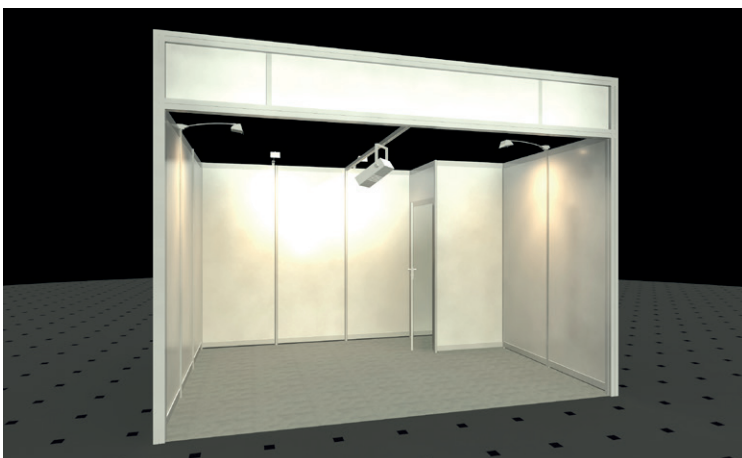

Example corner stand 5 x 4 m *



Example row stand 4 x 3 m

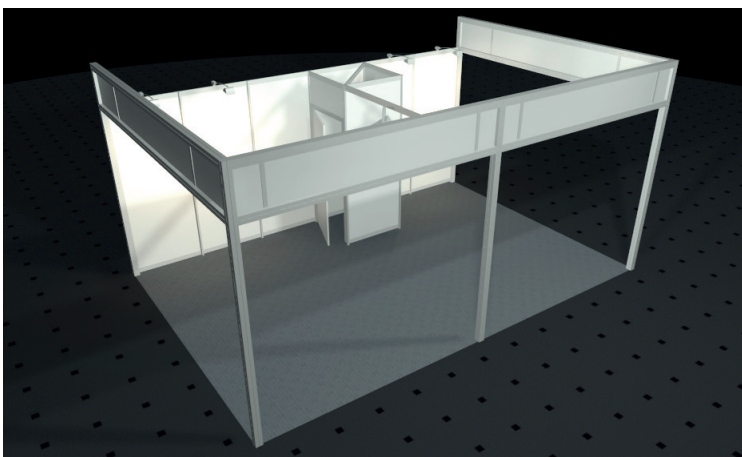

Example head stand 6 x 4 m

461 | OCTA_Display

A wide aluminium profile on the open side, and a large, tall panel give the OCTA_Display an elegant, modern look.

Description

- Special feature: A wide, square aluminium profile for supports and frames on the open sides, and a large panel area above the standard height (top edge 3 m)
- for stands with side lengths from 3 to 6 m (min. 12 sq-m)
- white walls, silver frames (Octanorm stand construction system)
- panels and walls suitable for signage*
- configurable as a row, corner or head stand (block stand possible on request)

Equipment

- lockable 1-sq-m booth
- coat rack, wastepaper basket
- 4 long arm spotlight* and 1 conductor rail with 1 HQI Spot
- carpet standard colour gray, B1 flame-retardant, other colours possible

Expandable with furniture, accessories and technology. Our catalog is available for download!

STAND CONSTRUCTION DETAILS

basic stand OCTA_Display #461

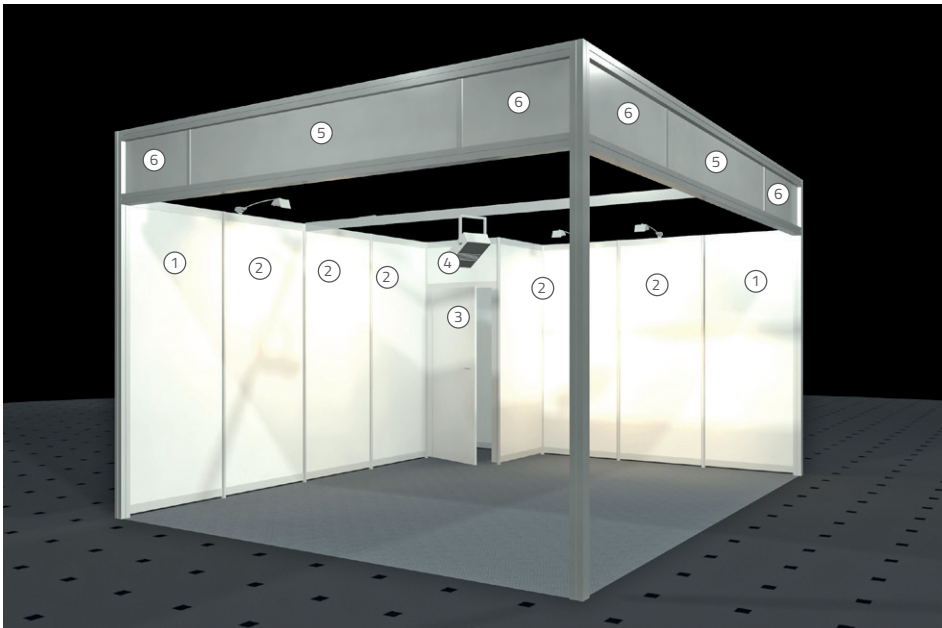

Attention: Picture shows example stand – please take size and appearance of your stand from the fair documents.

wall elements

- ① special size wall¹
400033/400084/400111
- ② standard wall #400001
- ③ cabin door #400004
- ④ wall over the door #400005
- ⑤ fascia board¹ #400029
- ⑥ fascia board refill
#400030/400031/400032

¹ Depending on the size and size and type of construction various panels with special dimensions. Please inquire if needed!

We would be pleased to submit you a non-binding offer for the **design and sticking** of your trade fair stand.

print size (in mm)

- print size
- visual size

Do you need help with creating the print data? We will be happy to advise you!

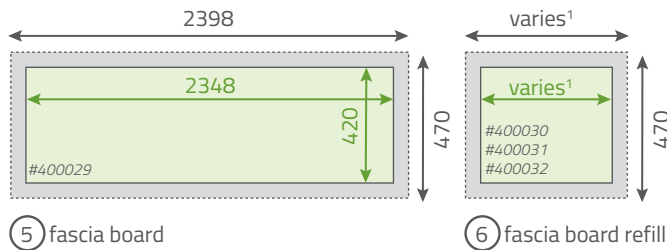

⑤ fascia board

⑥ fascia board refill

If you like to create your print data by yourself, please note:

- 4/0-coloured in **CMYK**
- printable PDF, scale **1:1** with **at least 100 dpi** (or on a scale of 1:10)
- **no crop marks/print marks, no bleed addition** (please note the dimensions on this sheet)
- **design** covering several walls has to be layouted **as separate graphic for each wall**
- **please add an overall view** of the stand, so we can see the position of each graphic
- name print data: **#article_standnumber_client_visualsize.pdf**. (Example: #400001_1B12_samplecompany_950x2380.pdf)
- **NOTE:** The **item number** is stated in the **offer**

IMPORTANT:

- all elements **extending the visual size** will be covered by the stand system.
- stand walls will be disrupted by a brace of **40 mm**

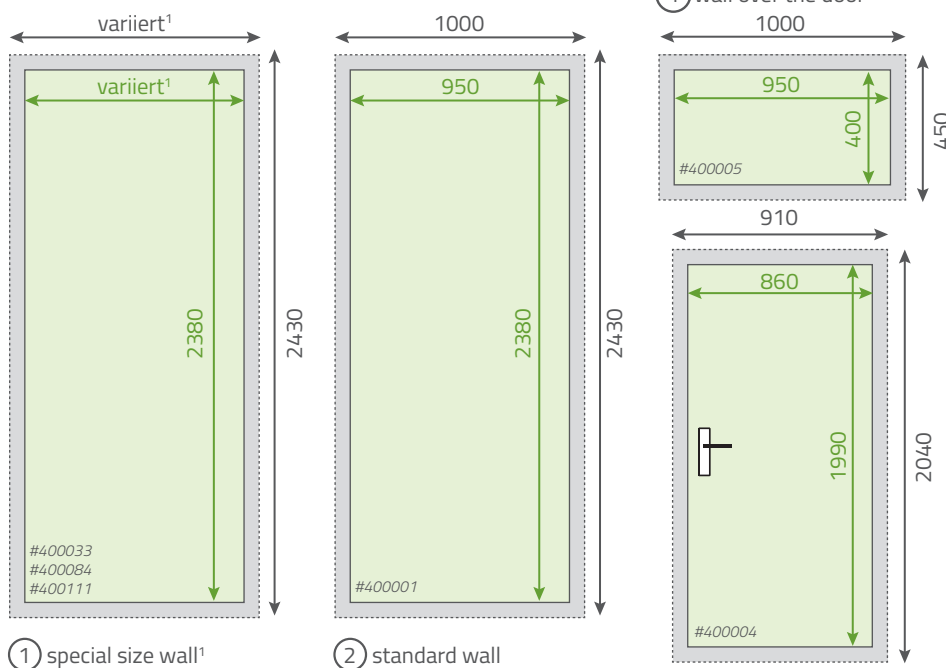

① special size wall¹

② standard wall

④ wall over the door²

③ cabin door²

² The wall over the door is flush with upper edge of standard wall. The distance between the wall over the door and cabin door= 50 mm (based on visible dimension).

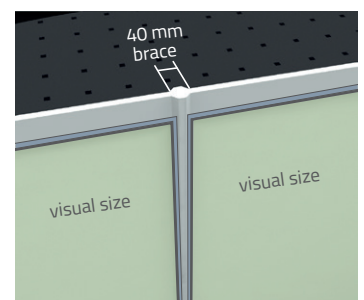

STAND CONSTRUCTION DETAILS

basic stand OCTA_Display



Example for design and equipment*
corner stand 5 x 4 m

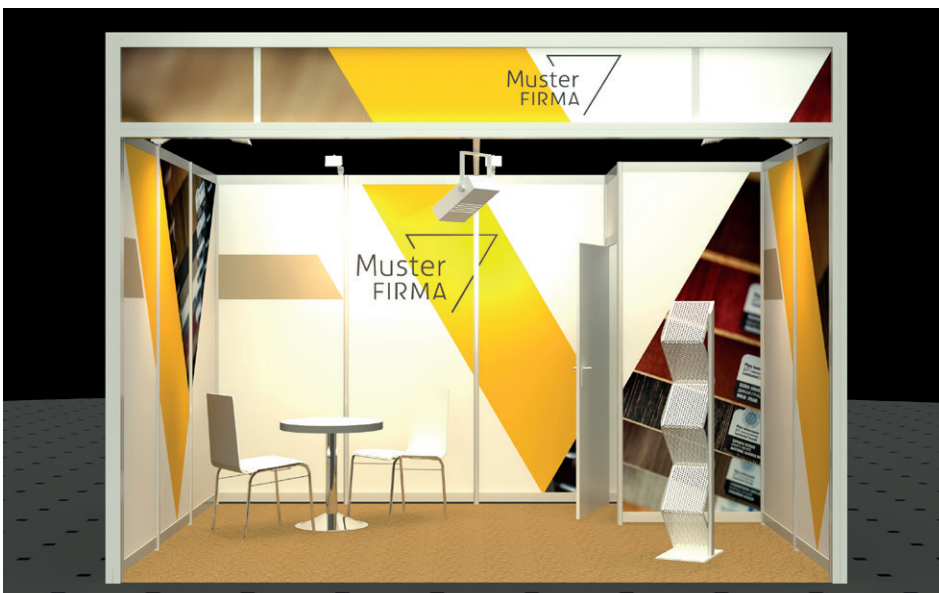

Example for design and equipment*
row stand 4 x 3 m

IMPORTANT

The examples on this page show optional features. They are not included in the basic price. We will be happy to advise you!



Example for design and equipment*
head stand 6 x 4 m

STAND CONSTRUCTION DETAILS

basic stand OCTA_Display

In addition to the basic stand, you may be interested in this rental furniture:



Item No. 210104
**Standing table bridge 120,
white, veneered**
120 x 110 x 80 cm



Item No. 528
Counter, lockable
100 x 100 x 50 cm



Item No. 201022
**Table Trompette elegance,
plate white**
Ø 70 cm, H: 72 cm



Item No. 483
High table stainless steel/white
70 x 70 cm, H: 110 cm



Item No. 588
chair Zeus
Chrome, seat shell and leather white
51 x 81 x 58 cm
seat height: 49 cm



Item No. 530
Bar stool with backrest
frame chrome,
seat upholstery leather white
40 x 45 cm (B x T)
seat height: 58 – 80 cm



Item No. 553
Brochure rack
6 shelves DIN A4, aluminium
zigzag
42 x 150 x 35 cm

